

3124-60 - 27239

Rectangular sealable tray, black

Product specifications

Material:	PP	Weight:	75,9 gr
Volume (nominal):	3300 ml	Length:	309 mm
Volume to rim:	3.360,1 ml	Width:	240 mm
Volume under lid*:	3.360,1 ml	Height:	60 mm
		Diameter:	mm

Afbeelding

* Volume under lid depends upon the lid used. Values shown are applicable when standard lid is used.

Packaging

Primary: # in primary packaging: 104 pieces

Secondary: # primary in secondary packaging: 1 piece
Weight gross: 8,56 kg

Tertiary: # in tertiary packaging: 18 boxes = 1.872 pieces
Weight gross: 174,08828 kg
Standard height: 750 mm

Uses / Certificates

Storage conditions: Keep out of direct sunlight, keep dry, store in original closed packaging, at ambient temperature, relative humidity between 40 and 70%.

Expiration: We recommend to use the products within 1 year after purchase. We can not be held responsible for use after this period.

Document retention: 3 years after purchase

All our products adhere to Regulation (EC) 1935/2004 and Regulation (EU) 10/2011 incl. amendments.

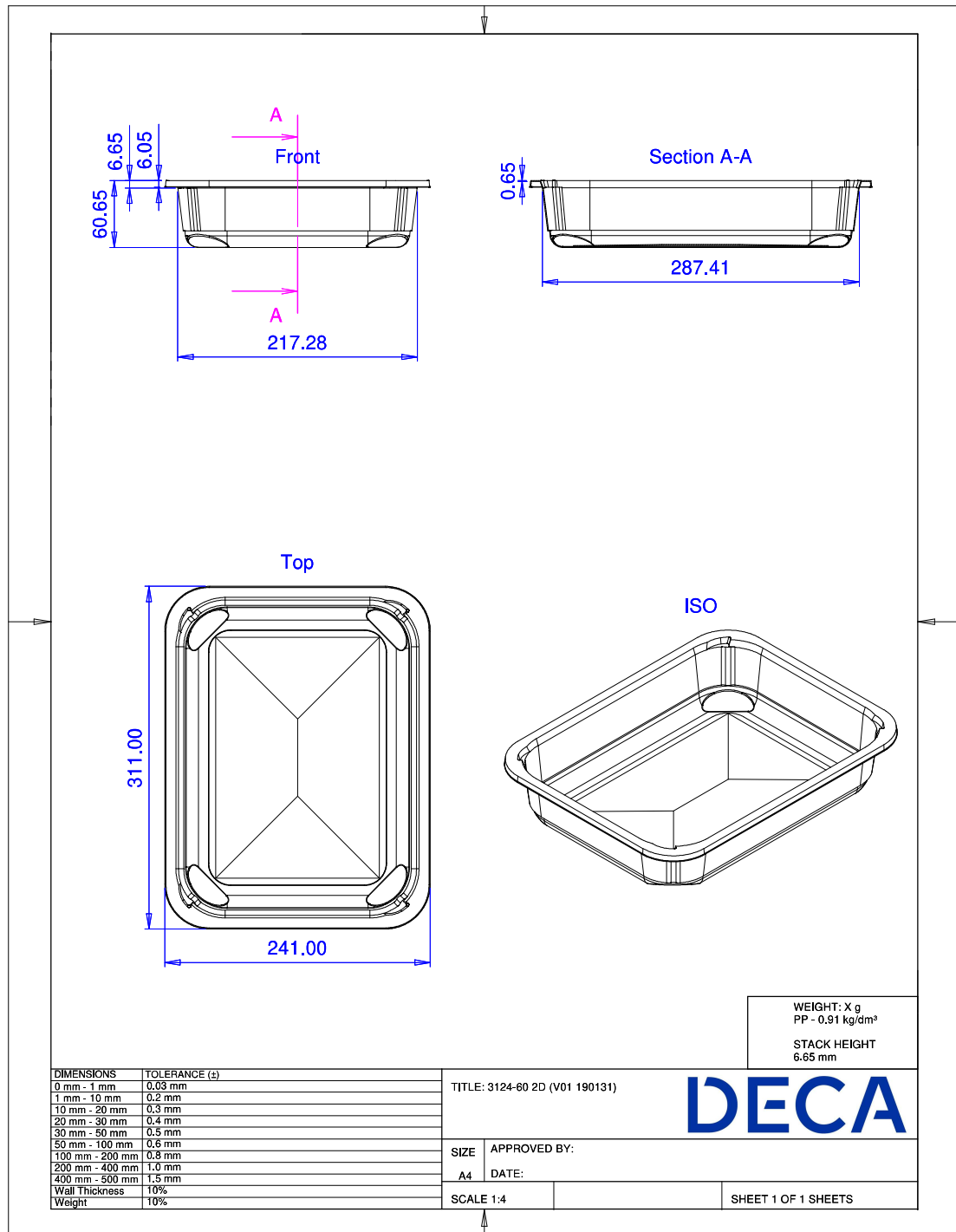

All our products adhere to Regulation (EC) 1935/2004 and Regulation (EU) 10/2011 incl. amendments.