

# 2314-55 - 25104

Rectangular, sealable tray, black

## Product specifications

Material:	PP	Weight:	32,7 gr
Volume (nominal):	1240 ml	Length:	231 mm
Volume to rim:	1.247 ml	Width:	146 mm
Volume under lid*:	1.247 ml	Height:	55 mm
		Diameter:	mm

Afbeelding

\* Volume under lid depends upon the lid used. Values shown are applicable when standard lid is used.

## Packaging

Primary:	Blue bag for TP/TPS/Tray/Neutral box # in primary packaging: 360 pieces
Secondary:	# primary in secondary packaging: 1 piece Weight gross: 12,8 kg
Tertiary:	Europallet, 150x1200x800 # in tertiary packaging: 20 boxes = 7.200 pieces Weight gross: 275,956 kg Standard height: 2.250 mm

## Uses / Certificates

Storage conditions:	Keep out of direct sunlight, keep dry, store in original closed packaging, at ambient temperature, relative humidity between 40 and 70%.
Expiration:	We recommend to use the products within 1 year after purchase. We can not be held responsible for use after this period.
Document retention:	3 years after purchase

All our products adhere to Regulation (EC) 1935/2004 and Regulation (EU) 10/2011 incl. amendments.

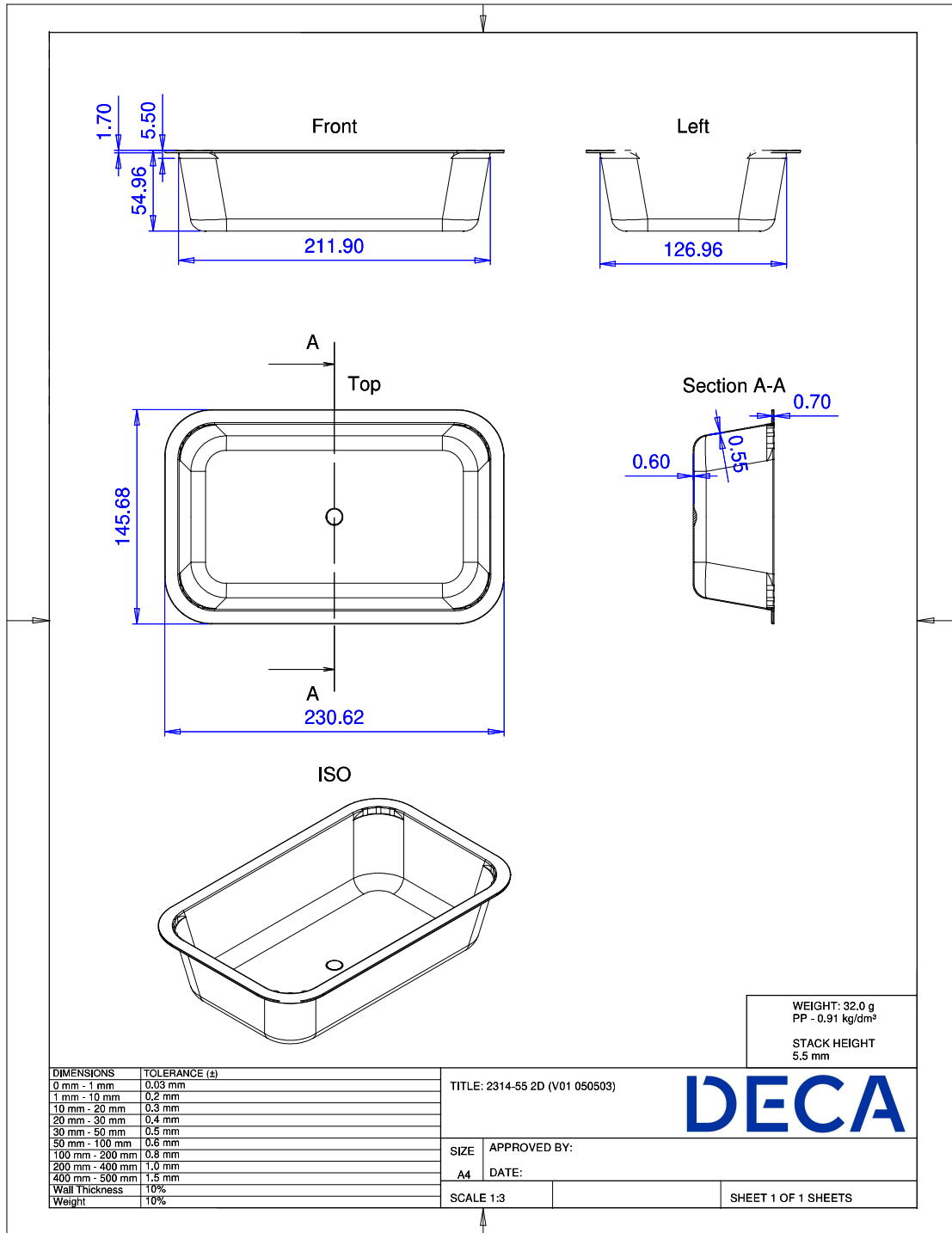

All our products adhere to Regulation (EC) 1935/2004 and Regulation (EU) 10/2011 incl. amendments.