

2014-54 - 26121

Rectangular, sealable tray, black

Product specifications

Material:	PP	Weight:	35,2 gr
Volume (nominal):	1125 ml	Length:	208 mm
Volume to rim:	1.153 ml	Width:	146 mm
Volume under lid*:	1.153 ml	Height:	54 mm
		Diameter:	mm

Afbeelding

* Volume under lid depends upon the lid used. Values shown are applicable when standard lid is used.

Packaging

Primary:	Blue bag for TP/TPS/Tray/Neutral box # in primary packaging: 420 pieces
Secondary:	# primary in secondary packaging: 1 piece Weight gross: 15,81 kg
Tertiary:	Europallet, 150x1200x800 # in tertiary packaging: 20 boxes = 8.400 pieces Weight gross: 336,196 kg Standard height: 2.250 mm

Uses / Certificates

Storage conditions:	Keep out of direct sunlight, keep dry, store in original closed packaging, at ambient temperature, relative humidity between 40 and 70%.
Expiration:	We recommend to use the products within 1 year after purchase. We can not be held responsible for use after this period.
Document retention:	3 years after purchase

All our products adhere to Regulation (EC) 1935/2004 and Regulation (EU) 10/2011 incl. amendments.

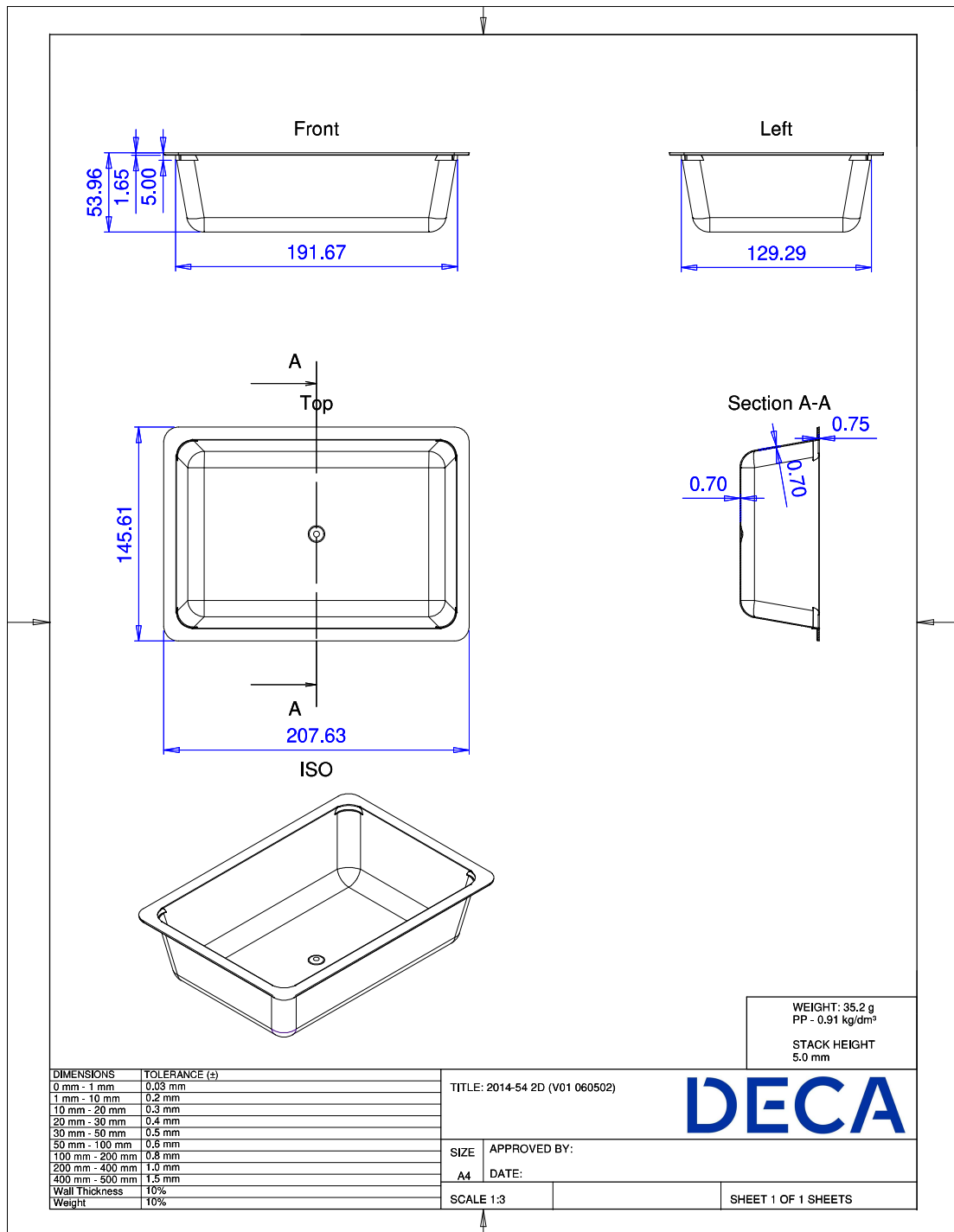

All our products adhere to Regulation (EC) 1935/2004 and Regulation (EU) 10/2011 incl. amendments.