

# 1309-75 - 23575

Rectangular, sealable tray, black

## Product specifications

Material:	PP	Weight:	15,5 gr
Volume (nominal):	540 ml	Length:	135 mm
Volume to rim:	570 ml	Width:	92 mm
Volume under lid*:	555 ml	Height:	75 mm
		Diameter:	mm

Afbeelding

\* Volume under lid depends upon the lid used. Values shown are applicable when standard lid is used.

## Packaging

Primary:	Blue bag for TP/TPS/Tray/Neutral box # in primary packaging: 896 pieces
Secondary:	# primary in secondary packaging: 1 piece Weight gross: 14,91 kg
Tertiary:	Europallet, 150x1200x800 # in tertiary packaging: 16 boxes = 14.336 pieces Weight gross: 258,6208 kg Standard height: 1.830 mm

## Uses / Certificates

Storage conditions:	Keep out of direct sunlight, keep dry, store in original closed packaging, at ambient temperature, relative humidity between 40 and 70%.
Expiration:	We recommend to use the products within 1 year after purchase. We can not be held responsible for use after this period.
Document retention:	3 years after purchase

All our products adhere to Regulation (EC) 1935/2004 and Regulation (EU) 10/2011 incl. amendments.

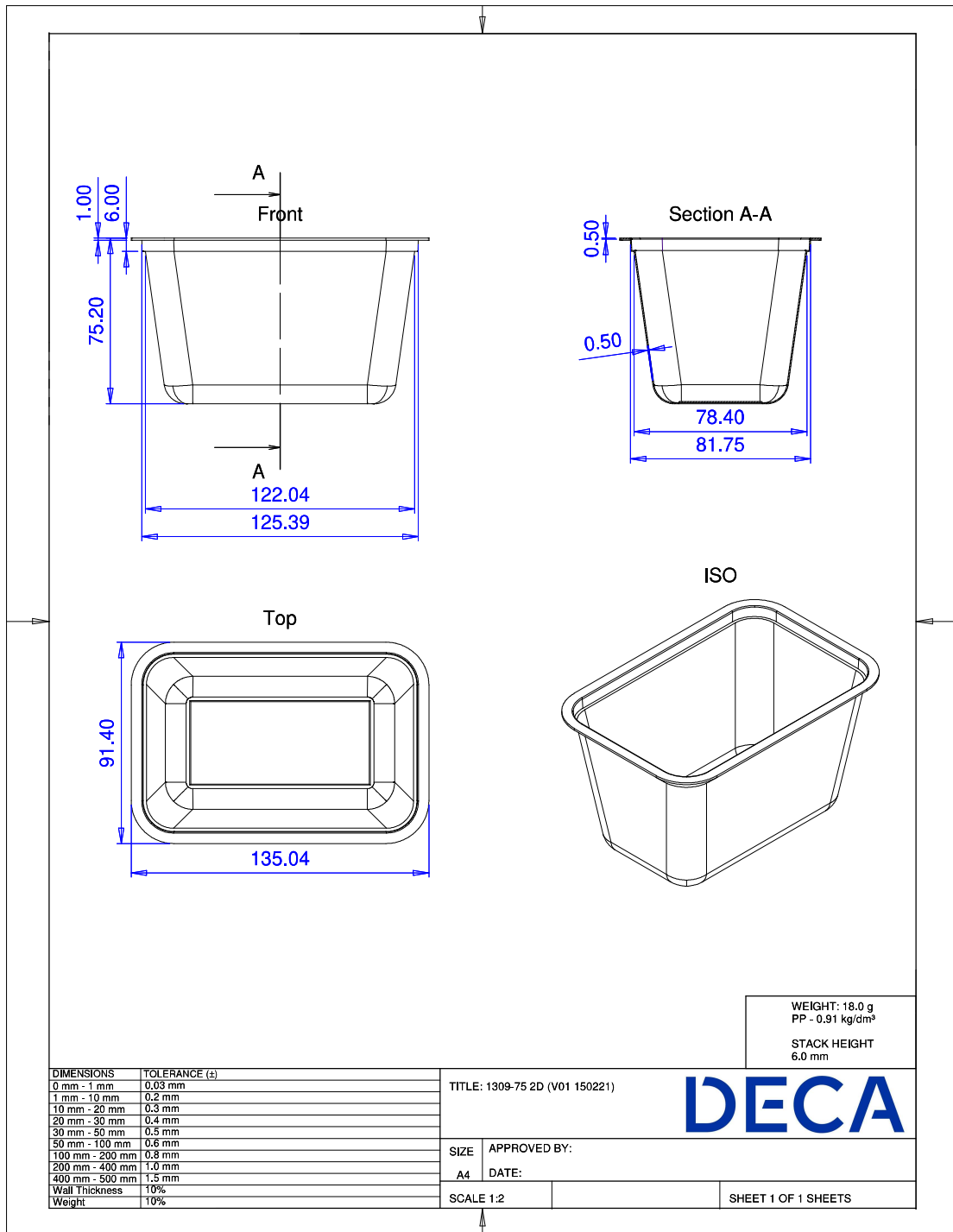

All our products adhere to Regulation (EC) 1935/2004 and Regulation (EU) 10/2011 incl. amendments.