

TPS192-4000 combi - 25183

Square container with lid and safety closure, transparent

Product specifications

Material:	PP	Weight:
Volume (nominal):		Length:
		Width:
		Height:
		Diameter:



* Volume under lid depends upon the lid used. Values shown are applicable when standard lid is used.

Packaging

Primary:	# in primary packaging: 48 pieces
Secondary:	# primary in secondary packaging: 1 piece Weight gross: 5,96 kg
Tertiary:	# in tertiary packaging: 24 boxes = 1.152 pieces Weight gross: 163,0592 kg Standard height: 0 mm

Uses / Certificates

Storage conditions:	Keep out of direct sunlight, keep dry, store in original closed packaging, at ambient temperature, relative humidity between 40 and 70%.
Expiration:	We recommend to use the products within 1 year after purchase. We can not be held responsible for use after this period.
Document retention:	3 years after purchase

All our products adhere to Regulation (EC) 1935/2004 and Regulation (EU) 10/2011 incl. amendments.

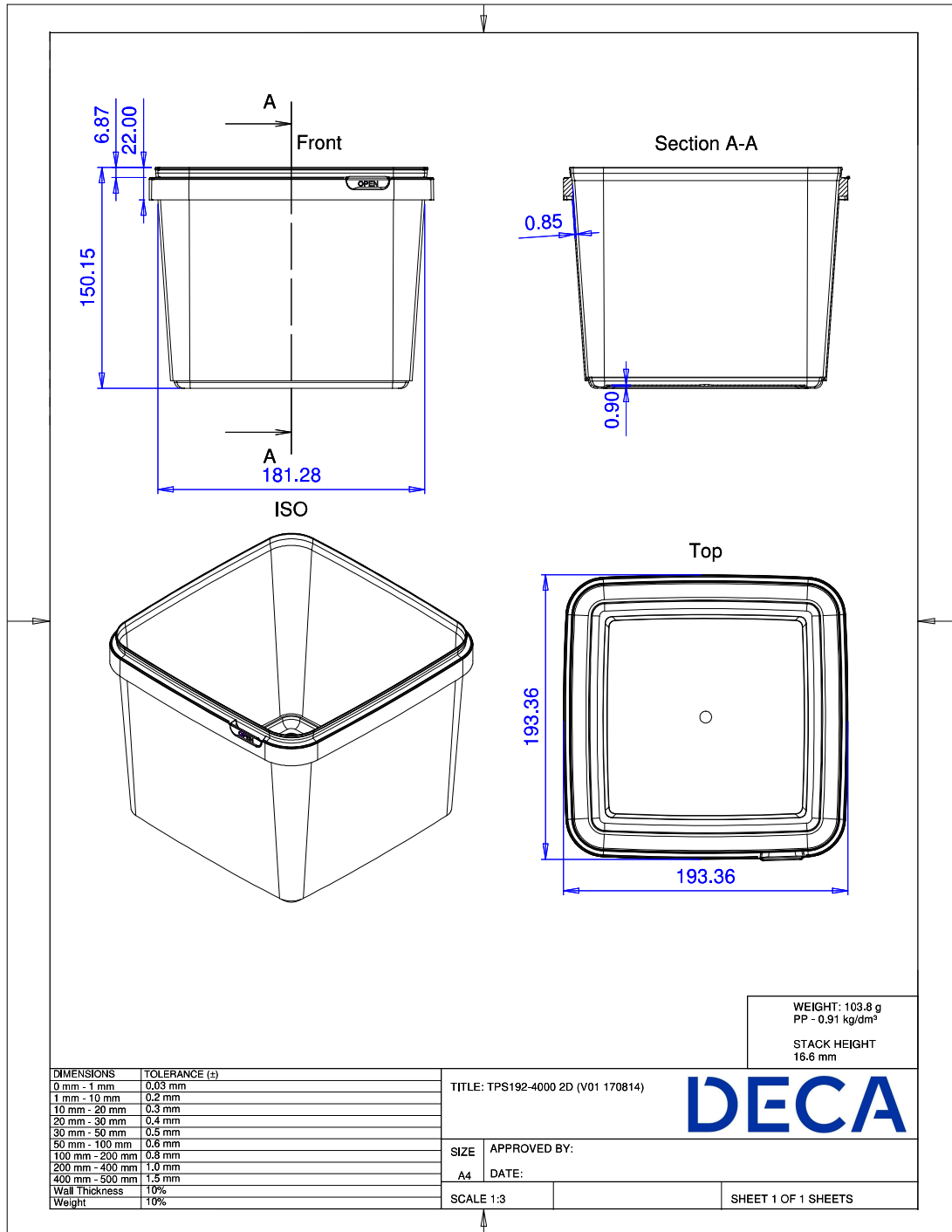

All our products adhere to Regulation (EC) 1935/2004 and Regulation (EU) 10/2011 incl. amendments.