

TPR1912-1600 - 23029

Rectangular container with safety closure, transparent

Product specifications

Material:	PP	Weight:	45,7 gr
Volume (nominal):	1600 ml	Length:	193 mm
Volume to rim:	1.790 ml	Width:	126 mm
Volume under lid*:	1.675 ml	Height:	97 mm
		Diameter:	mm



* Volume under lid depends upon the lid used. Values shown are applicable when standard lid is used.

Packaging

Primary:	# in primary packaging: 3744 pieces
Secondary:	# primary in secondary packaging: 1 piece Weight gross: 172,01 kg
Tertiary:	Europallet, 150x1200x800 # in tertiary packaging: 1 boxes = 3.744 pieces Weight gross: 192,01008 kg Standard height: 397 mm

Uses / Certificates

Storage conditions:	Keep out of direct sunlight, keep dry, store in original closed packaging, at ambient temperature, relative humidity between 40 and 70%.
Expiration:	We recommend to use the products within 1 year after purchase. We can not be held responsible for use after this period.
Document retention:	3 years after purchase

All our products adhere to Regulation (EC) 1935/2004 and Regulation (EU) 10/2011 incl. amendments.

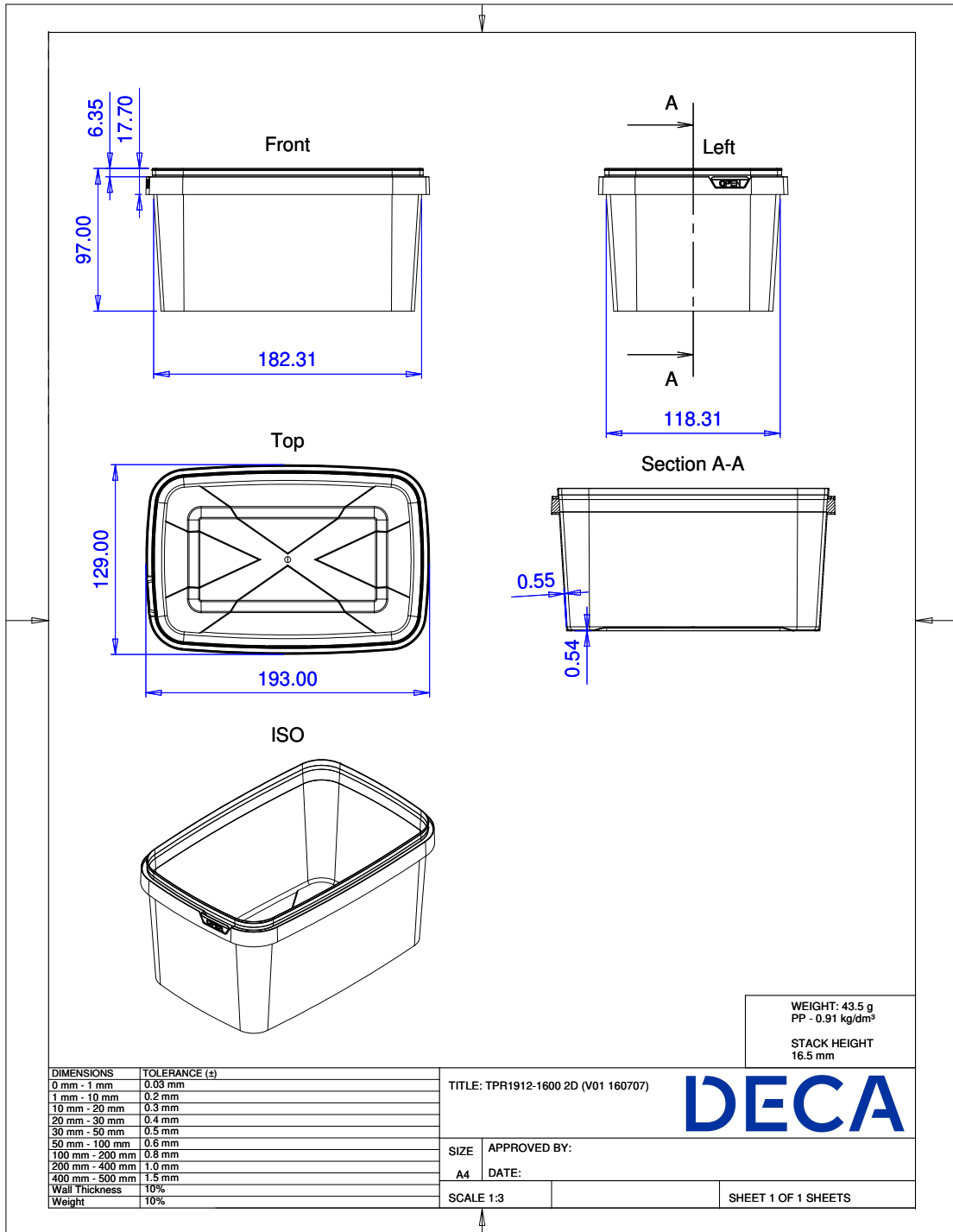

All our products adhere to Regulation (EC) 1935/2004 and Regulation (EU) 10/2011 incl. amendments.