

## TP95-225 combi - 23388

Round container with lid and safety closure, transparent

### Product specifications

Material:	PP	Weight:	17,1 gr
Volume (nominal):	225 ml	Length:	
		Width:	
		Height:	55 mm
		Diameter:	95 mm



\* Volume under lid depends upon the lid used. Values shown are applicable when standard lid is used.

### Packaging

Primary:	# in primary packaging: 494 pieces
Secondary:	Carton Deca TP 585, 400x600x400 # primary in secondary packaging: 1 piece Weight gross: 7,21 kg
Tertiary:	# in tertiary packaging: 20 boxes = 9.880 pieces Weight gross: 164,104 kg Standard height: 0 mm

### Uses / Certificates

Storage conditions:	Keep out of direct sunlight, keep dry, store in original closed packaging, at ambient temperature, relative humidity between 40 and 70%.
Expiration:	We recommend to use the products within 1 year after purchase. We can not be held responsible for use after this period.
Document retention:	3 years after purchase

All our products adhere to Regulation (EC) 1935/2004 and Regulation (EU) 10/2011 incl. amendments.

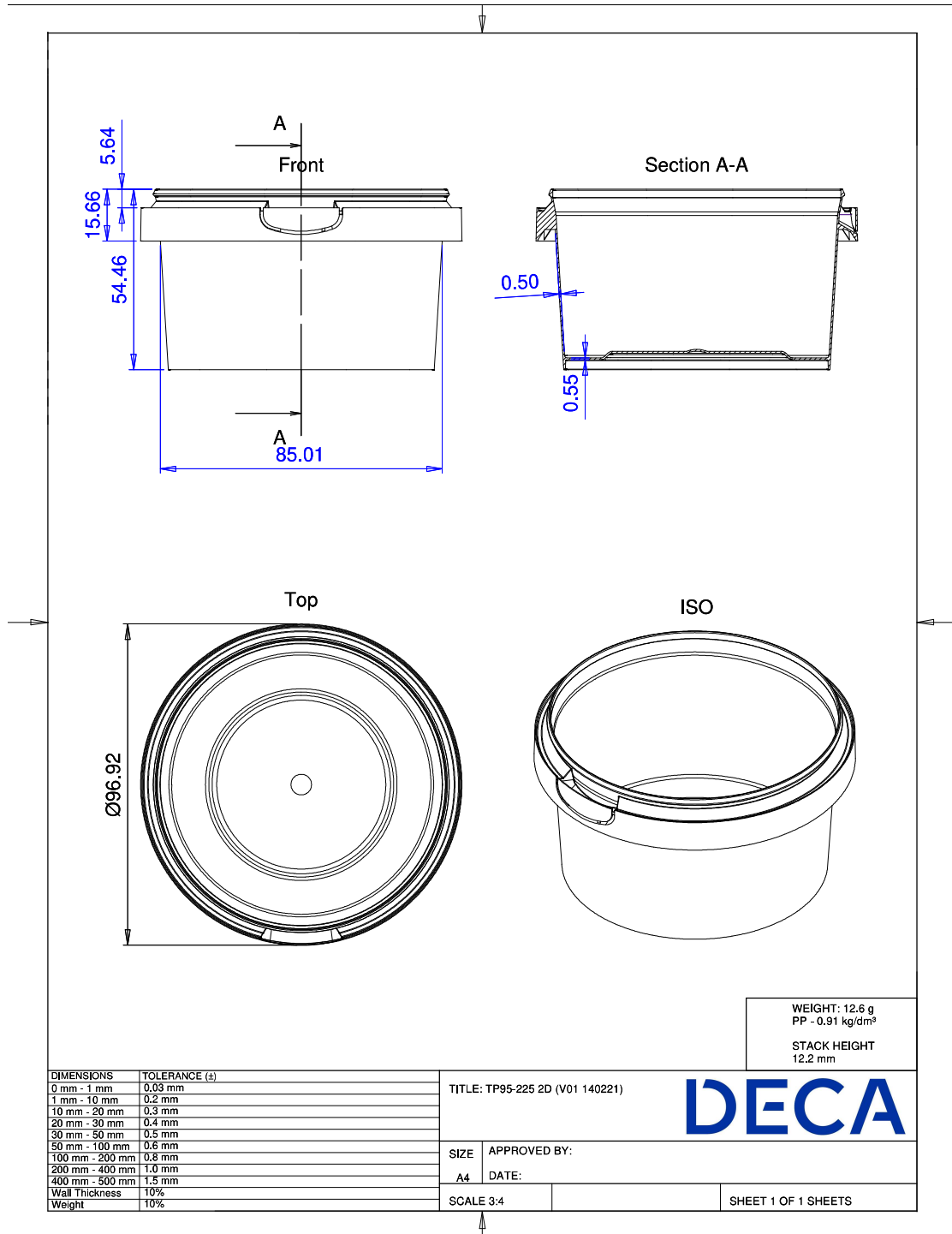

All our products adhere to Regulation (EC) 1935/2004 and Regulation (EU) 10/2011 incl. amendments.